



EPLAN P8

Elektrodokumentation Electrical documentation

Hersteller:
Manufacturer: Boll & Kirch Filterbau GmbH
Siemensstraße 10-14
50170 Kerpen

Algemeine Daten:
General informations:

BK-Artikel-Nr.: 4301050
BK-Article-No.:

Projektdatei:
Project data:

Zeichnungs-Nr.: Z46864
Drawing-No.:

Typ: Filtertyp 6.49 ME 1.1 DN200
Type: Filter type 6.49 ME 1.1 DN200

Bezeichnung: Vollautomatischer Rückspülfilter
Designation: Fully automatic back flushing filter

Anzahl Seiten: 27
Number of pages:

Bearbeiter: ogoericke
Edited by:

Datum: 06.05.2024
Date:

Normen:
Specifications: Ausführung der Schaltanlage nach DIN EN 61439-5:2015-10. Bestimmungen für fabrikfertige Schaltgerätekombinationen mit Nennspannung bis 750V. Nennisolationsspannung 450/750V und Nennspannung 450/750V.
Execution of the switchgear according to DIN EN 61439-5:2015-10. Regulations for factory-fabricated switchgear combinations with rated voltage up to 750V. Rated insulation voltage 450/750V and rated voltage 450/750V.

Technische Kenngrößen
Technical characteristics

Gehäuse:
Enclosure:

Bezeichnung: AX 1039.000
Designation:

Materialtyp: Stahlblech
Material: Carbon steel

Abmessungen: 600 x 380 x 210mm
Dimensionings:

Schutzart: IP65
Degree protection:

Farbe: RAL7035
Color:

Türanschlag: Rechts
Door stop: Right

Montage: Wandabstandshalter
Mounting: Wall spacer

Gewicht: 20,5kg+3,4kg(Box)
Weight:

Leitungsfarben:
Wire colors:

Arbeitsstromkreis: Schwarz
Load circuit: Black

Schutzleiter: Grün/Gelb
Protection conductor: Green/Yellow

Steuerstromkreis: Rot
Control circuit: Red

Fremdspannung: Orange
External voltage: Orange

Verdrahtung
Wiring

Hauptstromkreis wird mit 1,5mm² und Steuerstromkreis mit 1mm² verlegt.
Die Verdrahtung erfolgt von oben nach unten bzw. von links nach rechts gemäß den Stromlaufplänen.
The main circuit is laid with 1.5mm² and the control circuit with 1mm².
The wiring is carried out from top to bottom or from left to right according to the circuit diagrams.

Spannungen:
Voltages:

Betriebsspannung: 3~/PE
Operating voltage: 440V

Frequenz: 60Hz
Frequency:

Steuerspannung: 20V AC
Control voltage: 24V DC

Sonstiges:
Miscellaneous:

Aderbeschriftung: -
Wire labeling:

Kabeltyp: H07V-K
Cable type:

Netzform: IT
Network types:

Umgebungstemperatur: 55°C
Environment temperature:

Kurzschlussfestigkeit (SCCR): 50kA
Short-circuit strength (SCCR):

Steuergerät: BK2300
Control device:

Getriebemotor: 440VAC/0,33A
Gear motor:

Pumpenmotor: 4,55kW/8,00A
Pump motor:

weitere Hinweise:
other notes:

Kabeleinführung:
Cable entry:

oben
top unten
bottom

Hauptschalter:
Main switch:

vorne
Front

links
left

rechts
right

Kundenvorschriften:
Customer specifications:

Ja
Yes Nein
No

			Datum Date	06.05.2024		Hersteller Manufacturer Boll & Kirch Filterbau GmbH	Deckblatt Cover sheet Filtertyp 6.49 ME 1.1 DN200 Filter type 6.49 ME 1.1 DN200	BK-Artikel-Nr.: 4301050	=
			Bearbeiter Edited by	ogoricke				BK-Article-No.:	+
REV01	Göricke	12.12.2024	Auftrag Order					Zeichnungs-Nr.: Z46864	Blatt Page
Revision Revision	Bearbeiter Edited by	Datum Date	Vorgang Process			Drawing-No.:	von of	27	

Inhaltsverzeichnis Table of contents

Funktionskennzeichen function identifier	Einbauort Mounting location	Dokumentenart Document type	Seite Page	Seitenbezeichnung Page designation	Datum Date	Bearbeiter Edited by
		Schaltplan Wiring diagram	1	Deckblatt Cover sheet	12.12.2024	ogoricke
		Schaltplan Wiring diagram	2	Inhaltsverzeichnis Table of contents	12.12.2024	ogoricke
		Schaltplan Wiring diagram	3	Inhaltsverzeichnis Table of contents	12.12.2024	ogoricke
		Schaltplan Wiring diagram	4	Einspeisung und Stromversorgung Feed-in and power supply	12.12.2024	ogoricke
		Schaltplan Wiring diagram	5	Platine Circuit board	12.12.2024	ogoricke
		Schaltplan Wiring diagram	6	Getriebemotoren Gear motors	12.12.2024	ogoricke
		Schaltplan Wiring diagram	7	3-Wege Ventil 3-way valve	12.12.2024	ogoricke
		Schaltplan Wiring diagram	8	Sensoren Sensors	12.12.2024	ogoricke
		Schaltplan Wiring diagram	9	Reserve Spare	12.12.2024	ogoricke
		Schaltplan Wiring diagram	10	Bedienfeld Control panel	12.12.2024	ogoricke
		Schaltplan Wiring diagram	11	Aufbauplan Assembling diagram	12.12.2024	ogoricke
		Schaltplan Wiring diagram	12	Aufbauplan Assembling diagram	12.12.2024	ogoricke
		Materialliste Part list	1	Materialliste Part list	12.12.2024	ogoricke
		Materialliste Part list	2	Materialliste Part list	12.12.2024	ogoricke
		Materialliste Part list	3	Materialliste Part list	12.12.2024	ogoricke
		Klemmenplan Terminal diagram	1	Klemmenplan Terminal diagram	12.12.2024	ogoricke
		Klemmenplan Terminal diagram	2	Klemmenplan Terminal diagram	12.12.2024	ogoricke
		Klemmenplan Terminal diagram	3	Klemmenplan Terminal diagram	12.12.2024	ogoricke
		Klemmenplan Terminal diagram	4	Klemmenplan Terminal diagram	12.12.2024	ogoricke
		Klemmenplan Terminal diagram	5	Klemmenplan Terminal diagram	12.12.2024	ogoricke

			Datum Date	06.05.2024		Hersteller Manufacturer Boll & Kirch Filterbau GmbH	Inhaltsverzeichnis Table of contents Filtertyp 6.49 ME 1.1 DN200 Filter type 6.49 ME 1.1 DN200	BK-Artikel-Nr.: BK-Article-No.:	4301050	=
			Bearbeiter Edited by	ogoricke				+		
REV01	Göricke	12.12.2024	Auftrag Order					Blatt Page	2	
Revision Revision	Bearbeiter Edited by	Datum Date	Vorgang Process					von of	27	

Inhaltsverzeichnis Table of contents

Funktionskennzeichen function identifier	Einbauort Mounting location	Dokumentenart Document type	Seite Page	Seitenbezeichnung Page designation	Datum Date	Bearbeiter Edited by
		Klemmenplan Terminal diagram	6	Klemmenplan Terminal diagram	12.12.2024	ogoericke
		Klemmenplan Terminal diagram	7	Klemmenplan Terminal diagram	12.12.2024	ogoericke
		Klemmenplan Terminal diagram	8	Klemmenplan Terminal diagram	12.12.2024	ogoericke
		Klemmenplan Terminal diagram	9	Klemmenplan Terminal diagram	12.12.2024	ogoericke
		Klemmenplan Terminal diagram	10	Klemmenplan Terminal diagram	12.12.2024	ogoericke
		Klemmenplan Terminal diagram	11	Klemmenplan Terminal diagram	12.12.2024	ogoericke
		Klemmenplan Terminal diagram	12	Klemmenplan Terminal diagram	12.12.2024	ogoericke

			Datum Date	06.05.2024		Hersteller Manufacturer Boll & Kirch Filterbau GmbH	Inhaltsverzeichnis Table of contents Filtertyp 6.49 ME 1.1 DN200 Filter type 6.49 ME 1.1 DN200	BK-Artikel-Nr.: BK-Article-No.:	4301050	=
			Bearbeiter Edited by	ogoericke				+		
REV01	Göricke	12.12.2024	Auftrag Order					Blatt Page	3	
Revision Revision	Bearbeiter Edited by	Datum Date	Vorgang Process				Zeichnungs-Nr.: Drawing-No.:	Z46864	von of	27

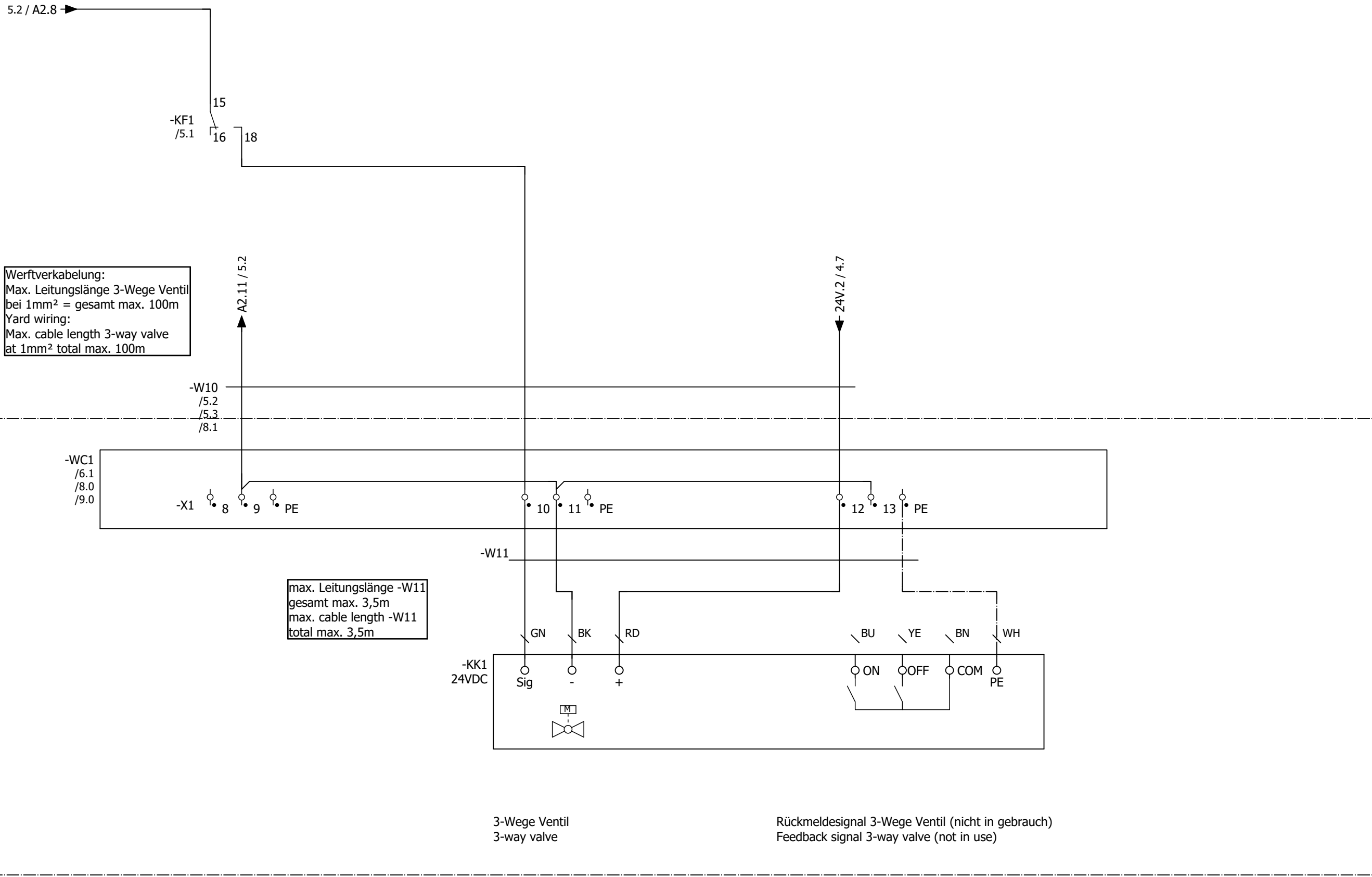

Wertverkabelung:
 Max. Leitungslänge 3-Wege Ventil bei 1mm² = gesamt max. 100m
 Yard wiring:
 Max. cable length 3-way valve at 1mm² total max. 100m

max. Leitungslänge -W11 gesamt max. 3,5m
 max. cable length -W11 total max. 3,5m

Alle nicht bezeichneten Leitungen = 1mm²
 All unnamed leads = 1mm²

			Datum Date	06.05.2024		Hersteller Manufacturer Boll & Kirch Filterbau GmbH	3-Wege Ventil 3-way valve Filtertyp 6.49 ME 1.1 DN200 Filter type 6.49 ME 1.1 DN200	BK-Artikel-Nr.: BK-Article-No.:	4301050	=			
REV01	Göricke	12.12.2024	Bearbeiter Edited by	ogoeरिके						Zeichnungs-Nr.: Drawing-No.:	Z46864	Blatt Page	7
Revision Revision	Bearbeiter Edited by	Datum Date	Auftrag Order	Vorgang Process								von of	27

Alle nicht bezeichneten
Leitungen = 1mm²
All unnamed leads = 1mm²

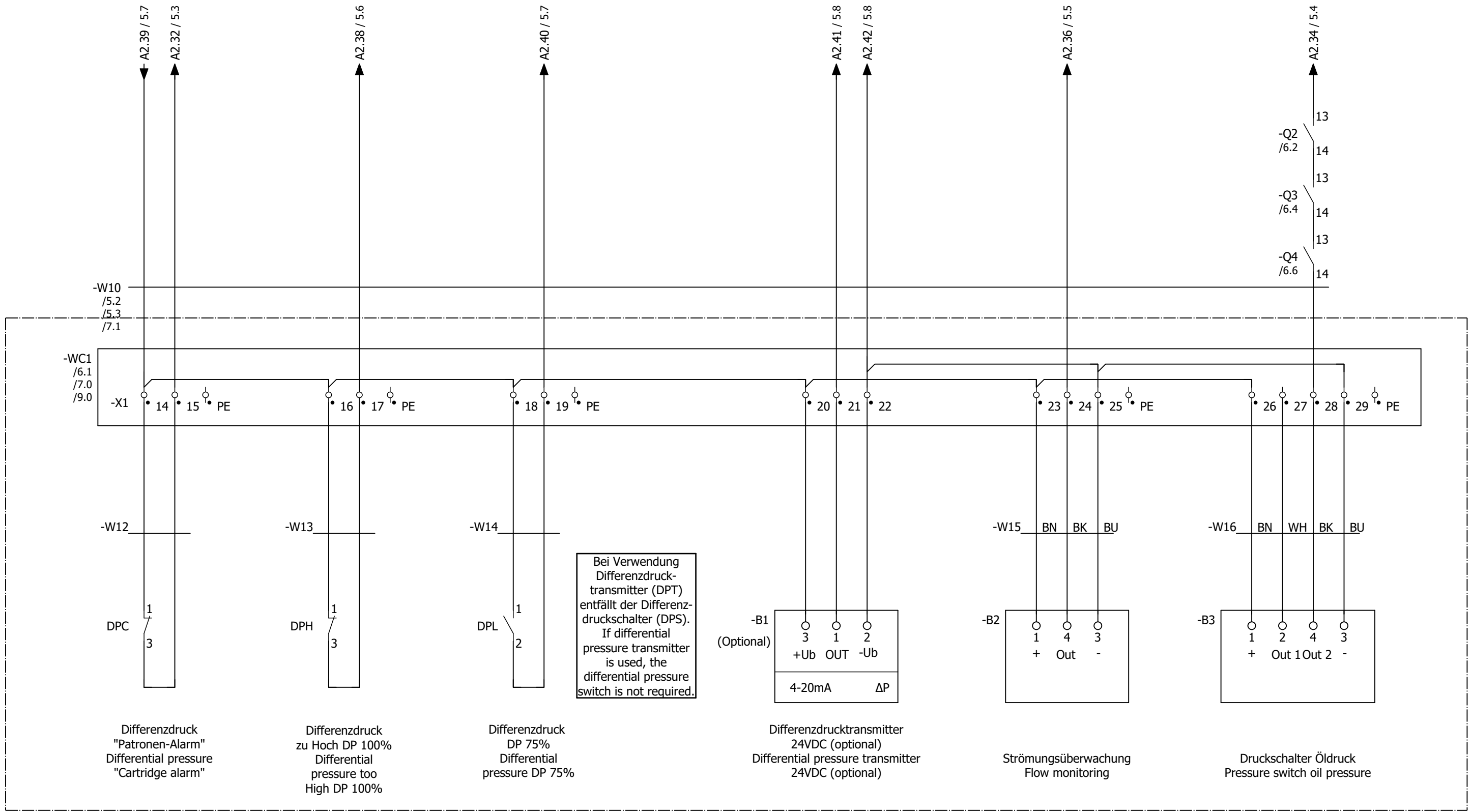

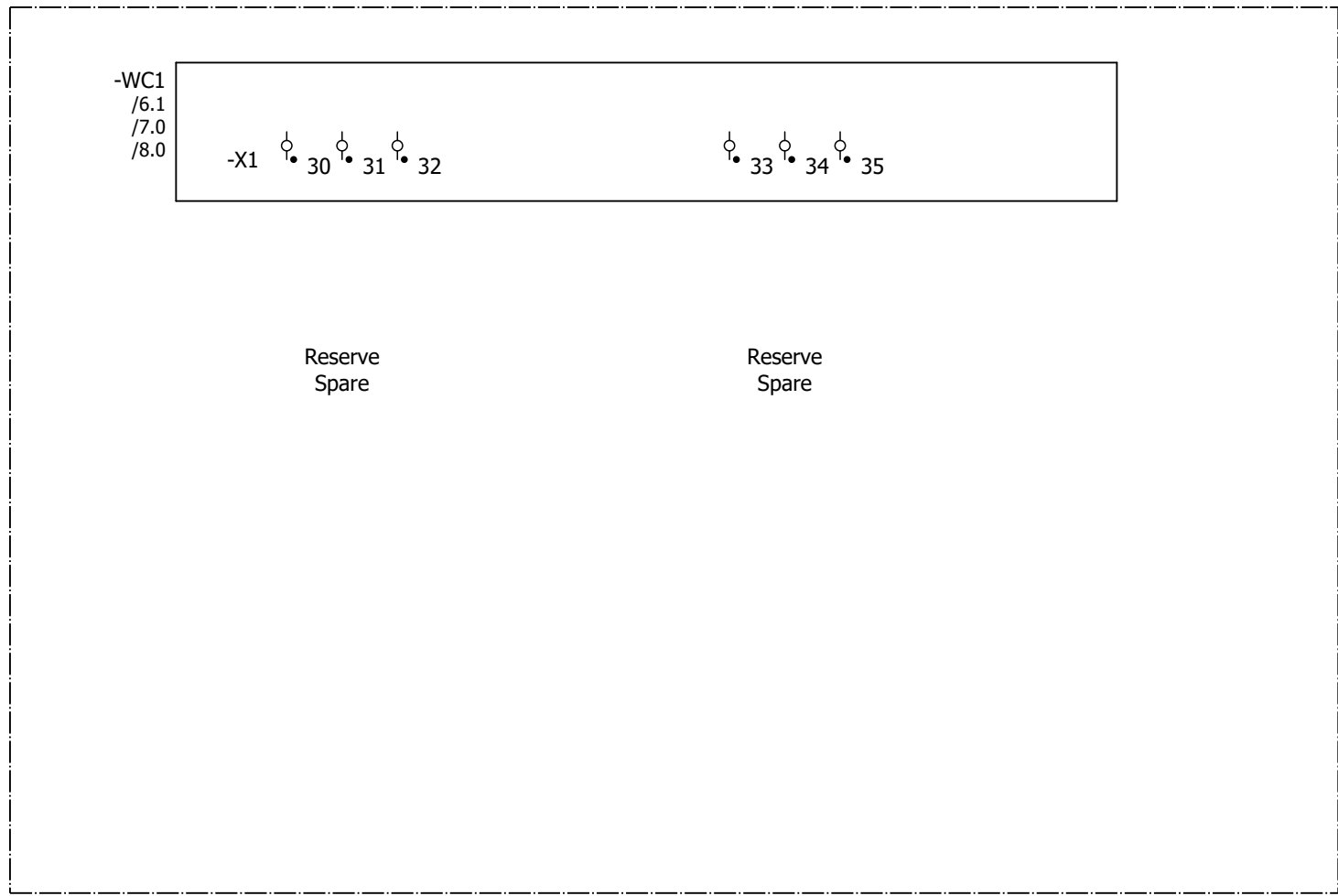

			Datum Date	06.05.2024		Hersteller Manufacturer	Sensoren Sensors	BK-Artikel-Nr.: BK-Article-No.:	4301050	=
			Bearbeiter Edited by	ogoeरिकe		Boll & Kirch Filterbau GmbH	Filtertyp 6.49 ME 1.1 DN200 Filter type 6.49 ME 1.1 DN200	Zeichnungs-Nr.: Drawing-No.:	Z46864	+
REV01	Göricke	12.12.2024	Auftrag Order							von
Revision Revision	Bearbeiter Edited by	Datum Date	Vorgang Process						of	27

Alle nicht bezeichneten
Leitungen = 1mm²
All unnamed leads = 1mm²

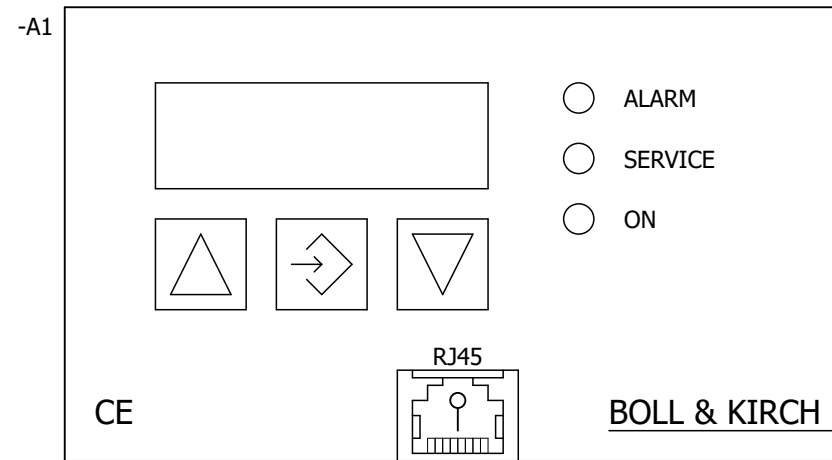

			Datum Date	06.05.2024		Hersteller Manufacturer	Reserve Spare	BK-Artikel-Nr.: BK-Article-No.:	4301050	=	
			Bearbeiter Edited by	ogoricke		Boll & Kirch Filterbau GmbH		Filtertyp 6.49 ME 1.1 DN200 Filter type 6.49 ME 1.1 DN200	Zeichnungs-Nr.: Drawing-No.:	Z46864	+
REV01	Göricke	12.12.2024	Auftrag Order								Blatt Page
Revision Revision	Bearbeiter Edited by	Datum Date	Vorgang Process						von of	27	



			Datum Date	06.05.2024		Hersteller Manufacturer	Bedienfeld Control panel	BK-Artikel-Nr.: BK-Article-No.:	4301050	=
			Bearbeiter Edited by	ogoericke		Boll & Kirch Filterbau GmbH	Filtertyp 6.49 ME 1.1 DN200 Filter type 6.49 ME 1.1 DN200	Zeichnungs-Nr.: Drawing-No.:	Z46864	+
REV01	Göricke	12.12.2024	Auftrag Order							Blatt Page
Revision Revision	Bearbeiter Edited by	Datum Date	Vorgang Process						von of	27

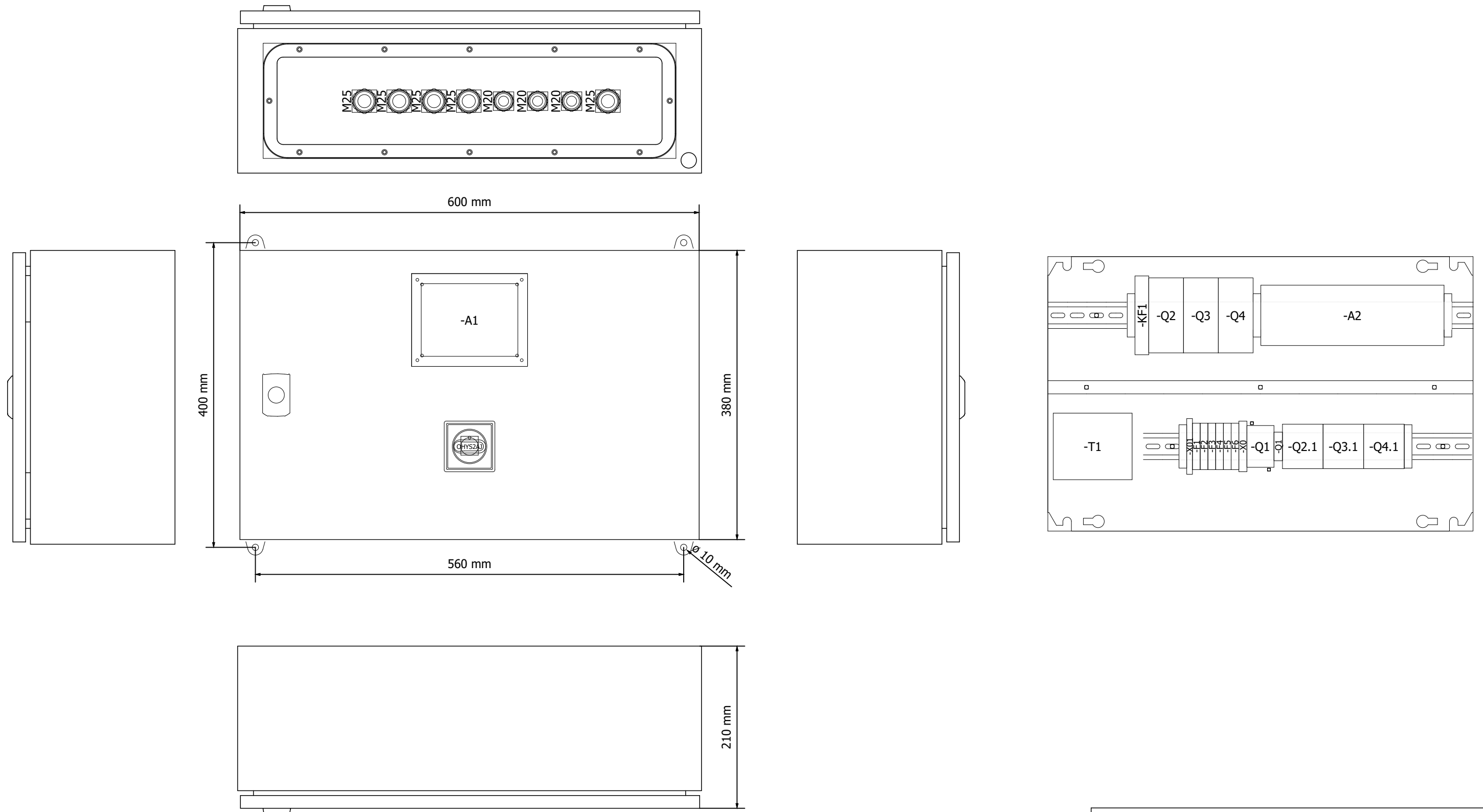

Reserve Sicherungssatz (bestehend aus: -A2-F1 / -A2-F1 / -F1 bis -F6)
 Reserve fuse set (consisting of: -A2-F1 / -A2-F2 / -F1 to -F6)
B&K ID 4300946

			Datum Date	06.05.2024		Hersteller Manufacturer	Aufbauplan Assembling diagram	BK-Artikel-Nr.: BK-Article-No.:	4301050	=
			Bearbeiter Edited by	ogoricke		Boll & Kirch Filterbau GmbH	Filtertyp 6.49 ME 1.1 DN200 Filter type 6.49 ME 1.1 DN200	Zeichnungs-Nr.: Drawing-No.:	Z46864	+
REV01	Göricke	12.12.2024	Auftrag Order							Blatt Page
Revision Revision	Bearbeiter Edited by	Datum Date	Vorgang Process						von of	27

- 1 Kabelverschraubung 1 für -M1 und -M2
EMSKV20-25 + MFD 25/02/080 (Wiska) [2x Ø6-8mm]
Cable gland 1 for -M1 and -M2
EMSKV20-25 + MFD 25/02/080 (Wiska) [2x Ø6-8mm] B&K ID3250014 (*)
- 2 Kabelverschraubung 2 für Pumpe -M3
EMSKV20-25 + RDE25 (Wiska) [1x Ø7-17mm]
Cable gland 2 for pump -M3
EMSKV20-25 + RDE25 (Wiska) [1x Ø7-17mm] B&K ID3250001 (*)
- 3 Kabelverschraubung 3 für -B2 und -B3
EMSKV20-25 + MFD 25/02/060 (Wiska) [2x Ø4-6mm]
Cable gland 3 for -B2 and -B3
EMSKV20-25 + MFD 25/02/060 (Wiska) [2x Ø4-6mm] B&K ID3250015 (*)
- 4 Kabelverschraubung 4 für DPC + DPH + DPL + KK1
EMSKV25-32 + MFD 32/03/070 (Wiska) [4x Ø5-7mm]
Cable gland 4 for DPC + DPH + DPL + KK1
EMSKV25-32 + MFD 32/03/070 (Wiska) [4x Ø5-7mm] B&K ID3250016 (*)
- 5 Verschlusschraube EMVS-ORD 25 (Wiska)
Stop end EMVS-ORD 25 (Wiska) B&K ID4100384 (*)

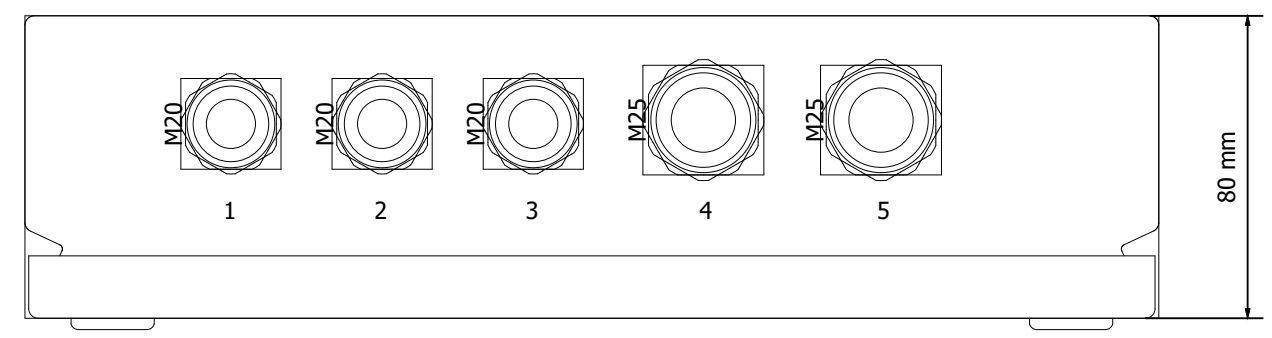
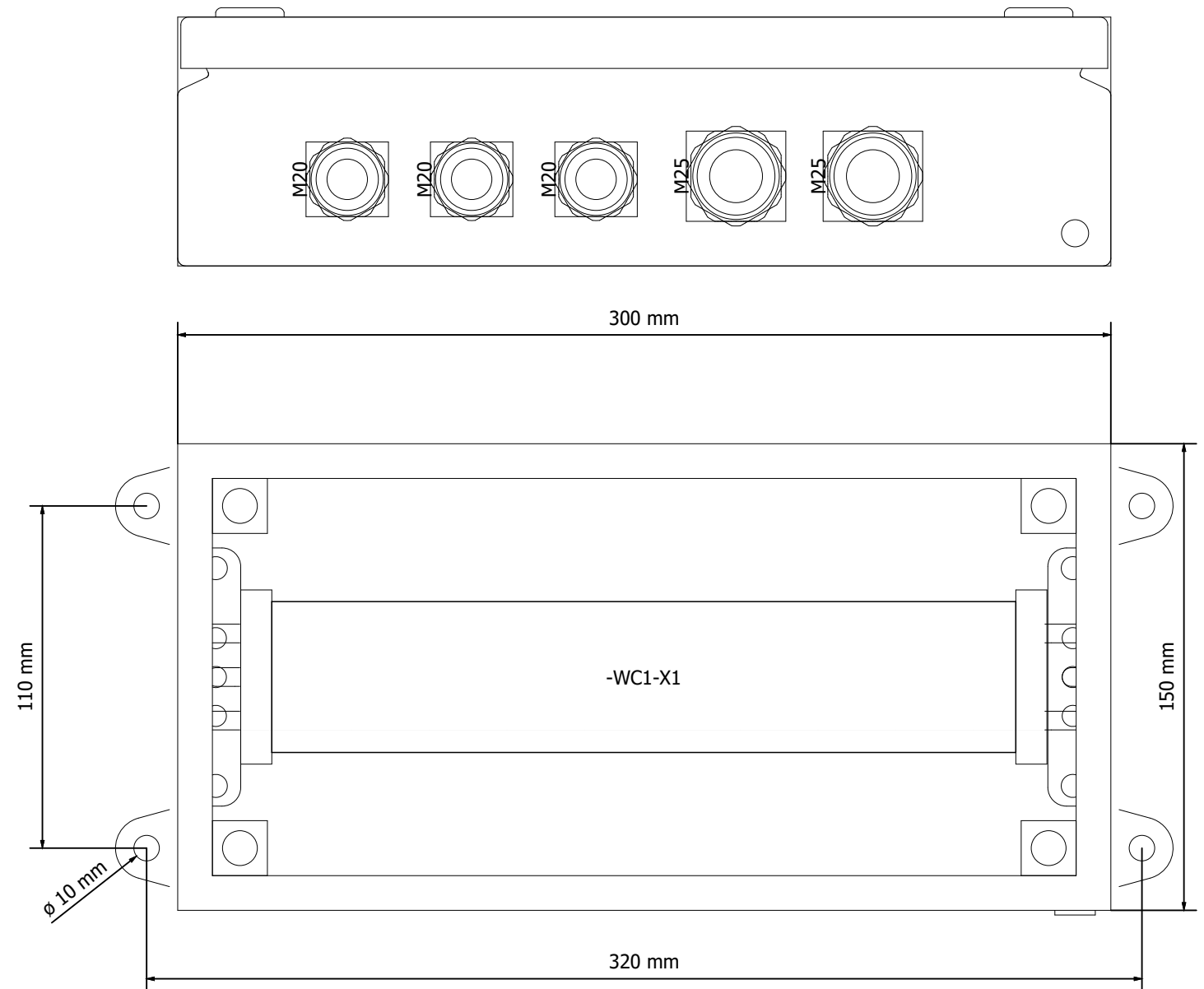

Version 1.1

(*)
Diese B&K Identnummern sind
im Umbausatz 6.49 ME
V0 zu V1.1 enthalten
(*)
These B&K identification
numbers are included in
the retrofit kit 6.49 V0 to V1.1!

separater Klemmenkasten
Separate terminal box

			Datum Date	06.05.2024		Hersteller Manufacturer	Aufbauplan Assembling diagram	BK-Artikel-Nr.: BK-Article-No.:	4301050	=
			Bearbeiter Edited by	ogoericke		Boll & Kirch Filterbau GmbH	Filtertyp 6.49 ME 1.1 DN200 Filter type 6.49 ME 1.1 DN200	Zeichnungs-Nr.: Drawing-No.:	Z46864	+
REV01	Göricke	12.12.2024	Auftrag Order							Blatt Page
Revision Revision	Bearbeiter Edited by	Datum Date	Vorgang Process						von of	27

Materialliste

Part list

Nr. No.	BMK DT	Anzahl Quant.	Bezeichnung Designation	Hersteller Manufacturer	Typ Type	Beschreibung Description	BK-Artikel-Nr.: BK-Article-No.:
1	-A1	1	Display	BOLL & KIRCH	BK2300	2 zeiliges universelles Display 2 lined universal Display	
2	-A1	1	Patchkabel Patch cable	Reco	SFTP	1m, RJ 45	4100403
3	-A2	1	E/A-Modul I/O-Modul	BOLL & KIRCH	BK2300 ME 6.49	IN 20VAC, 6DI, 5 Relaisausgänge, 3 Ventilausgänge, Steuerung für BK2300, ME 6.49 6.49 6.49 IN 20VAC, 6DI, 5 Relay outputs, 3 Valve outputs, Controller for BK2300, ME 6.49 6.49 6.49	4300905
4	-A2-F1	1	Schmelzsicherung Safety fuse	ESKA	522.516	0,8A, 5x20mm, Träge 0,8A, 5x20mm, Passive	4200162
5	-A2-F2	1	Schmelzsicherung Safety fuse	ESKA	522.520	2A, 5x20mm, Träge 2A, 5x20mm, Passive	4200163
6	-F1	1	Sicherungsklemme Fused terminal	Conta-Clip	SIK 10/Z BG	10 mm², NS35, Beige, Schraubanschluss 10 mm², NS35, Fawn, Screw terminal	4200526
7	-F1	1	Schmelzsicherung Safety fuse	ESKA	632.717	1A, 6,3x32mm, Träge 1A, 6,3x32mm, Passive	4200146
8	-F2	1	Sicherungsklemme Fused terminal	Conta-Clip	SIK 10/Z BG	10 mm², NS35, Beige, Schraubanschluss 10 mm², NS35, Fawn, Screw terminal	4200526
9	-F2	1	Schmelzsicherung Safety fuse	ESKA	632.717	1A, 6,3x32mm, Träge 1A, 6,3x32mm, Passive	4200146
10	-F3	1	Sicherungsklemme Fused terminal	Conta-Clip	SIK 10/Z BG	10 mm², NS35, Beige, Schraubanschluss 10 mm², NS35, Fawn, Screw terminal	4200526
11	-F3	1	Schmelzsicherung Safety fuse	ESKA	632.719	1,6A, 6,3x32mm, Träge 1,6A, 6,3x32mm, Passive	4200264
12	-F4	1	Sicherungsklemme Fused terminal	Conta-Clip	SIK 10/Z BG	10 mm², NS35, Beige, Schraubanschluss 10 mm², NS35, Fawn, Screw terminal	4200526
13	-F4	1	Schmelzsicherung Safety fuse	ESKA	632.719	1,6A, 6,3x32mm, Träge 1,6A, 6,3x32mm, Passive	4200264
14	-F5	1	Sicherungsklemme Fused terminal	Conta-Clip	SIK 10/Z BG	10 mm², NS35, Beige, Schraubanschluss 10 mm², NS35, Fawn, Screw terminal	4200526
15	-F5	1	Schmelzsicherung Safety fuse	ESKA	632.712	315mA, 6,3x32mm, Träge 315mA, 6,3x32mm, Passive	4200700
16	-F6	1	Sicherungsklemme Fused terminal	Conta-Clip	SIK 10/Z BG	10 mm², NS35, Beige, Schraubanschluss 10 mm², NS35, Fawn, Screw terminal	4200526
17	-F6	1	Schmelzsicherung Safety fuse	ESKA	632.712	315mA, 6,3x32mm, Träge 315mA, 6,3x32mm, Passive	4200700
18	-KF1	1	Taktrelais timing relay	Siemens	3RP2555-1AW30	0,05s - 100h, 12-240VUC, 50 / 60Hz, 1 Wechsler, 15 Zeitbereiche, Schraubanschluss 0,05s - 100h, 12-240VUC, 50 / 60Hz, 1 Change-over contact, 15 Time ranges, Screw terminal	4200729
19	-Q1	1	Lasttrennschalter Load interrupter	ABB	OT16F3	3 Polig, 16A, Bodenbefestigung 3 Pole, 16A, Bottom mounting	4200866
20	-Q1	1	Hilfskontakt Auxiliary contact	ABB	OA1G10	16A, 1NO, seitlich, für OT16...OT125 Hauptschalter 16A, 1NO, side mounting, for OT16...OT125 Main switch	4200617

			Datum Date	06.05.2024		Hersteller Manufacturer	Materialliste Part list Filtertyp 6.49 ME 1.1 DN200 Filter type 6.49 ME 1.1 DN200	BK-Artikel-Nr.: BK-Article-No.:	4301050	=	
			Bearbeiter Edited by	ogoeरिके		Boll & Kirch Filterbau GmbH		Zeichnungs-Nr.: Drawing-No.:	4301050 Z46864	+	
REV01	Göricke	12.12.2024	Auftrag Order							Blatt Page	13
Revision Revision	Bearbeiter Edited by	Datum Date	Vorgang Process							von of	27

Materialliste

Part list

Nr. No.	BMK DT	Anzahl Quant.	Bezeichnung Designation	Hersteller Manufacturer	Typ Type	Beschreibung Description	BK-Artikel-Nr.: BK-Article-No.:
21	-Q1	1	Hauptschaltergriff Main switch handle	ABB	OHYS2AJ	Rot/Gelb, IP65, NEMA 1 Red/Yellow, IP65, NEMA 1	4200866
22	-Q1	1	Hauptschalterwelle Main switch shaft	ABB	OXS6X180	180mm	4200866
23	-Q2	1	Leistungsschalter Power circuit breaker	Siemens	3RV2011-0EA10	0.28-0.4A, BGR S00, CLASS 10, Schraubanschluss 0.28-0.4A, BGR S00, CLASS 10, Screw terminal	4200473
24	-Q2	1	Hilfsschalter Auxiliary switch	Siemens	3RV2901-1E	1NC+1NO, querliegend, für BGR. S00 / S0, Schraubanschluss 1NC+1NO, transversely, for BGR. S00 / S0, Screw terminal	4100257
25	-Q2.1	1	Leistungsschutz Power contactor	ABB	BC6-30-10	4kW, 1NO, 24VDC, Schraubanschluss 4kW, 1NO, 24VDC, Screw terminal	4200148
26	-Q3	1	Leistungsschalter Power circuit breaker	Siemens	3RV2011-0EA10	0.28-0.4A, BGR S00, CLASS 10, Schraubanschluss 0.28-0.4A, BGR S00, CLASS 10, Screw terminal	4200473
27	-Q3	1	Hilfsschalter Auxiliary switch	Siemens	3RV2901-1E	1NC+1NO, querliegend, für BGR. S00 / S0, Schraubanschluss 1NC+1NO, transversely, for BGR. S00 / S0, Screw terminal	4100257
28	-Q3.1	1	Leistungsschutz Power contactor	ABB	BC6-30-10	4kW, 1NO, 24VDC, Schraubanschluss 4kW, 1NO, 24VDC, Screw terminal	4200148
29	-Q4	1	Leistungsschalter Power circuit breaker	Siemens	3RV2011-1JA10	7-10A, BGR. S00, CLASS10, Schraubanschluss 7-10A, BGR. S00, CLASS10, Screw terminal	4200778
30	-Q4	1	Hilfsschalter Auxiliary switch	Siemens	3RV2901-1E	1NC+1NO, querliegend, für BGR. S00 / S0, Schraubanschluss 1NC+1NO, transversely, for BGR. S00 / S0, Screw terminal	4100257
31	-Q4.1	1	Leistungsschutz Power contactor	ABB	BC6-30-10	4kW, 1NO, 24VDC, Schraubanschluss 4kW, 1NO, 24VDC, Screw terminal	4200148
32	-T1	1	Steuertransformator Control transformer	MDEXX	TAM3496-0EJ00-0FA2	einphasig, 65VA, IN 220-550VAC, OUT 20VAC 220VAC 24VDC, 50/60Hz, IP00, Schraubanschluss single-phase, 65VA, IN 220-550VAC, OUT 20VAC 220VAC 24VDC, 50/60Hz, IP00, Screw terminal	4200524
33	-WC1-X1	35	Durchgangsklemme Feed-through terminal block	Phoenix Contact	ST 2,5	2,5 mm ² , NS35, Grau, Zugfederanschluss 2,5 mm ² , NS35, Gray, Cage clamp connection	4100547
34	-WC1-X1	1	Abschlussdeckel End cover	Phoenix Contact	D-ST 2,5	Grau, ST 2,5 Klemme Gray, ST 2,5 Terminal	4100119
35	-WC1-X1	11	Schutzleiterklemme Protective conductor terminal	Phoenix Contact	ST 2,5-PE	4 mm ² , NS35, Grün/Gelb, Zugfederanschluss 4 mm ² , NS35, Green/Yellow, Cage clamp connection	4100548
36	-WC1-X1	2	Steckbrücke Plug-in bridge	Phoenix Contact	FBS 10-5	10er, 2,5mm ² Klemmen 10er, 2,5mm ² Terminals	4100558
37	-WC1-X1	1	Steckbrücke Plug-in bridge	Phoenix Contact	FBS 20-5	20er, für 2,5mm ² Klemmen 20er, for 2,5mm ² Terminals	4100559
38	-X0	2	Schutzleiterklemme Protective conductor terminal	Phoenix Contact	UT 2,5-QUATTRO-PE	4mm ² , NS35, Grün/Gelb, Schraubanschluss 4mm ² , NS35, Green/Yellow, Screw terminal	4100073
39	-X01	1	Durchgangsklemme Feed-through terminal block	Phoenix Contact	ST 2,5-QUATTRO	4mm ² , NS35, Grau, Zugfederanschluss 4mm ² , NS35, Gray, Cage clamp connection	4100549
40	-X01	1	Abschlussdeckel End cover	Phoenix Contact	D-ST 2,5-QUATTRO	Grau Gray	4100551

			Datum Date	06.05.2024		Hersteller Manufacturer	Materialliste Part list Filtertyp 6.49 ME 1.1 DN200 Filter type 6.49 ME 1.1 DN200	BK-Artikel-Nr.: BK-Article-No.:	4301050	=		
			Bearbeiter Edited by	ogoeरिके						+		
REV01	Göricke	12.12.2024	Auftrag Order			Boll & Kirch Filterbau GmbH			Zeichnungs-Nr.: Drawing-No.:	Z46864	Blatt Page	14
Revision Revision	Bearbeiter Edited by	Datum Date	Vorgang Process								von of	27

Materialliste

Part list

Nr. No.	BMK DT	Anzahl Quant.	Bezeichnung Designation	Hersteller Manufacturer	Typ Type	Beschreibung Description	BK-Artikel-Nr.: BK-Article-No.:
41	-Z1	1	Wandschrank Wall cabinet	Rittal	AX 1039.199 Y289549	600 x 380 x 210mm, Stahl, RAL7035, bearbeitet 600 x 380 x 210mm, Steel, RAL7035, edited	4301094
42	-Z1	1	Wandbefestigungshalter Wall mounting bracket	Rittal	KX 1590.010	10 mm, für AX und KX, Stahl 10 mm, for AX and KX, Steel	4300840
43	-Z1	3	Kabelverschraubung Cable gland	WISKA	EMSKV 20-25 EMV-Z	M20, Messing, vernickelt, EMV-fest, Kabeldurchmesser 9-17mm M20, Brass, nickel-plated, EMC-proof, Cable diameter 9-17mm	4100097
44	-Z1	3	Gegenmutter Locknut	WISKA	EMMU 20	M20, Messing, vernickelt M20, Brass, nickel-plated	4100309
45	-Z1	5	Kabelverschraubung Cable gland	WISKA	EMSKV 25-32 EMV-Z	M25, Messing, vernickelt, EMV-fest, Kabeldurchmesser 13-21mm M25, Brass, nickel-plated, EMC-proof, Cable diameter 13-21mm	4100098
46	-Z1	5	Gegenmutter Locknut	WISKA	EMMU 25	M25, Messing, vernickelt M25, Brass, nickel-plated	4100310
47	-Z1	5	Reduzierdichteinsatz Reduced seal insert	WISKA	RDE 25	Kabeldurchmesser 7-12mm, für M25 Kabelverschraubung Cable diameter 7-12mm, for M25 Cable gland	3250001
48	-Z1	5	Endwinkel End angle	Conta-Clip	ZES 35/2 BG	Beige, für NS35 Tragschiene Fawn, for NS35 Mounting rail	4100311
49	-Z2	1	Klemmenkasten Terminal box	Rittal	KX 1515.199 Y289548	300 x 150 x 80mm, Lackiert, RAL7035, IP65, bearbeitet 300 x 150 x 80mm, Lacquered, RAL7035, IP65, edited	4301095
50	-Z2	1	Wandbefestigungshalter Wall mounting bracket	Rittal	KX 1590.010	10 mm, für AX und KX, Stahl 10 mm, for AX and KX, Steel	4300840
51	-Z2	6	Kabelverschraubung Cable gland	WISKA	EMSKV 20-25 EMV-Z	M20, Messing, vernickelt, EMV-fest, Kabeldurchmesser 9-17mm M20, Brass, nickel-plated, EMC-proof, Cable diameter 9-17mm	4100097
52	-Z2	6	Gegenmutter Locknut	WISKA	EMMU 20	M20, Messing, vernickelt M20, Brass, nickel-plated	4100309
53	-Z2	4	Kabelverschraubung Cable gland	WISKA	EMSKV 25-32 EMV-Z	M25, Messing, vernickelt, EMV-fest, Kabeldurchmesser 13-21mm M25, Brass, nickel-plated, EMC-proof, Cable diameter 13-21mm	4100098
54	-Z2	4	Gegenmutter Locknut	WISKA	EMMU 25	M25, Messing, vernickelt M25, Brass, nickel-plated	4100310
55	-Z2	2	Dichteinsatz Seal insert	Jacob GmbH	WJ-DM25/4x6	für M25 Verschraubung, 4 x 6mm for M25 Screw connection, 4 x 6mm	3250030
56	-Z2	2	Reduzierdichteinsatz Reduced seal insert	WISKA	RDE 25	Kabeldurchmesser 7-12mm, für M25 Kabelverschraubung Cable diameter 7-12mm, for M25 Cable gland	3250001
57	-Z2	2	Endwinkel End angle	Conta-Clip	ZES 35/2 BG	Beige, für NS35 Tragschiene Fawn, for NS35 Mounting rail	4100311

			Datum Date	06.05.2024		Hersteller Manufacturer	Materialliste Part list	BK-Artikel-Nr.: BK-Article-No.:	4301050	=	
			Bearbeiter Edited by	ogoeरिके							+
REV01	Göricke	12.12.2024	Auftrag Order					Boll & Kirch Filterbau GmbH	Filtertyp 6.49 ME 1.1 DN200 Filter type 6.49 ME 1.1 DN200	Zeichnungs-Nr.: Drawing-No.:	Z46864
Revision Revision	Bearbeiter Edited by	Datum Date	Vorgang Process						von of	27	

Klemmenplan Terminal diagram

Funktionstext Function text	Kabeltyp Cable type	Kabelname Cable name	=+ #-F1 Sicherung Transformator primärseitig Fuse transformer primary side						
			Zielbezeichnung Target designation				Zielbezeichnung Target designation		
			Bezeichnung Designation	Anschluss Connection	Klemme Terminal	Brücke Jumper	Bezeichnung Designation	Anschluss Connection	Blatt Page Pfad Path
L1			-T1	4			-Q1;-Q2	L1;1	&1/4.7

Klemmenplan Terminal diagram

Funktionstext Function text	Kabelname Cable name	= + # - F2 Sicherung Transformator primärseitig Fuse transformer primary side											
	Kabeltyp Cable type	Zielbezeichnung Target designation					Zielbezeichnung Target designation						
		Bezeichnung Designation	Anschluss Connection	Klemme Terminal	Brücke Jumper	Bezeichnung Designation	Anschluss Connection	Blatt Page	Pfad Path				
L3		-T1	1			-Q1;-Q3	L3;5	&1/4.5					

			Datum Date	06.05.2024		Hersteller Manufacturer	Klemmenplan Terminal diagram	BK-Artikel-Nr.: BK-Article-No.:	4301050	=
			Bearbeiter Edited by	ogoricke		Boll & Kirch Filterbau GmbH	Filtertyp 6.49 ME 1.1 DN200 Filter type 6.49 ME 1.1 DN200	Zeichnungs-Nr.: Drawing-No.:	Z46864	+
REV01	Göricke	12.12.2024	Auftrag Order							Blatt Page
Revision Revision	Bearbeiter Edited by	Datum Date	Vorgang Process				von of		27	

Klemmenplan Terminal diagram

Funktionstext Function text	Kabeltyp Cable type	Kabelname Cable name	= + # - F3 Sicherung Transformator sekundärseitig Fuse transformer secondary side																		
			Zielbezeichnung Target designation					Zielbezeichnung Target designation													
			Bezeichnung Designation	Anschluss Connection	Klemme Terminal	Brücke Jumper	Bezeichnung Designation	Anschluss Connection	Blatt Page	Pfad Path											
24V			-X01					-T1	12	&1/4.7											

			Datum Date	06.05.2024		Hersteller Manufacturer	Klemmenplan Terminal diagram	BK-Artikel-Nr.: BK-Article-No.:	4301050	=
			Bearbeiter Edited by	ogoricke		Boll & Kirch Filterbau GmbH	Filtertyp 6.49 ME 1.1 DN200 Filter type 6.49 ME 1.1 DN200			+
REV01	Göricke	12.12.2024	Auftrag Order							Zeichnungs-Nr.: Drawing-No.:
Revision Revision	Bearbeiter Edited by	Datum Date	Vorgang Process						von of	27

Klemmenplan Terminal diagram

Funktionstext Function text	Kabelname Cable name						= + #-F4 Sicherung Transformator sekundärseitig Fuse transformer secondary side					
	Kabeltyp Cable type						Zielbezeichnung Target designation		Zielbezeichnung Target designation			
							Bezeichnung Designation	Anschluss Connection	Klemme Terminal	Brücke Jumper	Bezeichnung Designation	Anschluss Connection
GND						-A2	7			-T1	11	&1/4.7

			Datum Date	06.05.2024		Hersteller Manufacturer	Klemmenplan Terminal diagram	BK-Artikel-Nr.: BK-Article-No.:	4301050	=
			Bearbeiter Edited by	ogoricke		Boll & Kirch Filterbau GmbH	Filtertyp 6.49 ME 1.1 DN200 Filter type 6.49 ME 1.1 DN200	Zeichnungs-Nr.: Drawing-No.:	Z46864	+
REV01	Göricke	12.12.2024	Auftrag Order							Blatt Page
Revision Revision	Bearbeiter Edited by	Datum Date	Vorgang Process				von of			27

Klemmenplan Terminal diagram

Funktionstext Function text	Kabeltyp Cable type	Kabelname Cable name	=+ #-F5 Sicherung Transformator sekundärseitig Fuse transformer secondary side													
			Zielbezeichnung Target designation					Zielbezeichnung Target designation								
			Bezeichnung Designation	Anschluss Connection	Klemme Terminal	Brücke Jumper	Bezeichnung Designation	Anschluss Connection	Blatt Page	Pfad Path						
L20			-A2	5			-T1	14	&1/4.8							

		Datum Date	06.05.2024		Hersteller Manufacturer	Klemmenplan Terminal diagram	BK-Artikel-Nr.: BK-Article-No.:	4301050	=	
		Bearbeiter Edited by	ogoericke		Boll & Kirch Filterbau GmbH	Filtertyp 6.49 ME 1.1 DN200 Filter type 6.49 ME 1.1 DN200	Zeichnungs-Nr.: Drawing-No.:	Z46864	+	
REV01	Göricke	Datum Date	12.12.2024							
Revision Revision	Bearbeiter Edited by		Vorgang Process						von of	27

Klemmenplan Terminal diagram

Funktionstext Function text	Kabeltyp Cable type	Kabelname Cable name	= + # - F6 Sicherung Transformator sekundärseitig Fuse transformer secondary side						
			Zielbezeichnung Target designation		Zielbezeichnung Target designation		Klemme Terminal	Brücke Jumper	Blatt Page Pfad Path
			Bezeichnung Designation	Anschluss Connection	Bezeichnung Designation	Anschluss Connection			
L0.20			-A2	4			-T1	13	&1/4.7

			Datum Date	06.05.2024		Hersteller Manufacturer	Klemmenplan Terminal diagram	BK-Artikel-Nr.: BK-Article-No.:	4301050	=			
			Bearbeiter Edited by	ogoyericke		Boll & Kirch Filterbau GmbH	Filtertyp 6.49 ME 1.1 DN200 Filter type 6.49 ME 1.1 DN200			+			
REV01	Göricke	12.12.2024	Auftrag Order							Zeichnungs-Nr.: Drawing-No.:	Z46864	Blatt Page	21
Revision Revision	Bearbeiter Edited by	Datum Date	Vorgang Process									von of	27

Klemmenplan Terminal diagram

Funktionstext Function text	Kabelname Cable name	Kabeltyp Cable type	-W11	-W7	-W5	-W3	=+#-WC1-X1 Klemmenbox Terminal box					-W2	-W4	-W6	-W10		
			Zielbezeichnung Target designation		Zielbezeichnung Target designation		Blatt Page Pfad Path										
			Bezeichnung Designation	Anschluss Connection	Klemme Terminal	Brücke Jumper		Bezeichnung Designation	Anschluss Connection								
Getriebemotor 1 Gear motor 1							-M1-X1	1	1	·	-Q2.1	2	&1/6.2				
Getriebemotor 1 Gear motor 1							-M1-X1	2	2	·	-Q2.1	4	&1/6.2				
Getriebemotor 1 Gear motor 1							-M1-X1	PE	PE	·			&1/6.2				
Getriebemotor 2 Gear motor 2							-M2-X1	1	3	·	-Q3.1	2	&1/6.4				
Getriebemotor 2 Gear motor 2							-M2-X1	2	4	·	-Q3.1	6	&1/6.4				
Getriebemotor 2 Gear motor 2							-M2-X1	PE	PE	·			&1/6.4				
Pumpe Pump							-M3	U1	5	·	-Q4.1	2	&1/6.6				
Pumpe Pump							-M3	V1	6	·	-Q4.1	4	&1/6.6				
Pumpe Pump							-M3	W1	7	·	-Q4.1	6	&1/6.6				
Pumpe Pump							-M3	PE	PE	·	-X0	PE	&1/6.6				
									8	·			&1/7.1				
3-Wege Ventil 3-way valve									9	·	-A2	11	&1/7.1				
									PE	·			&1/7.2				
3-Wege Ventil 3-way valve			GN				-KK1	Sig	10	·	-KF1	18	&1/7.3				

			Datum Date	06.05.2024		Hersteller Manufacturer	Klemmenplan Terminal diagram	BK-Artikel-Nr.: BK-Article-No.:	4301050	=
			Bearbeiter Edited by	ogoeरिके		Boll & Kirch Filterbau GmbH	Filtertyp 6.49 ME 1.1 DN200 Filter type 6.49 ME 1.1 DN200	Zeichnungs-Nr.: Drawing-No.:	Z46864	+
REV01	Göricke	12.12.2024	Auftrag Order							Blatt Page
Revision Revision	Bearbeiter Edited by	Datum Date	Vorgang Process				von of	27		

Klemmenplan Terminal diagram

Funktionstext Function text	Kabeltyp Cable type	Kabelname Cable name	-W14	-W13	-W12	-W11	=+#-WC1-X1 Klemmenbox Terminal box					-W10							
			Zielbezeichnung Target designation					Zielbezeichnung Target designation											
			Bezeichnung Designation	Anschluss Connection	Klemme Terminal	Brücke Jumper	Bezeichnung Designation	Anschluss Connection	Blatt Page Pfad Path										
3-Wege Ventil 3-way valve						BK	-KK1	-	11	·									
									PE	·									
3-Wege Ventil 3-way valve						RD	-KK1	+	12	·									
									13	·									
3-Wege Ventil 3-way valve						WH	-KK1	PE	PE	·									
Differenzdruck "Patronen-Alarm" Differential pressure "Cartridge alarm"								1	14	·				-A2	39				
Differenzdruck "Patronen-Alarm" Differential pressure "Cartridge alarm"								3	15	·				-A2	32				
Differenzdruck "Patronen-Alarm" Differential pressure "Cartridge alarm"									PE	·									
Differenzdruck zu Hoch DP 100% Differential pressure too High DP 100%								1	16	·									
Differenzdruck zu Hoch DP 100% Differential pressure too High DP 100%								3	17	·				-A2	38				
Differenzdruck zu Hoch DP 100% Differential pressure too High DP 100%									PE	·									
Differenzdruck DP 75% Differential pressure DP 75%								1	18	·									
Differenzdruck DP 75% Differential pressure DP 75%								2	19	·				-A2	40				
Differenzdruck DP 75% Differential pressure DP 75%									PE	·									

			Datum Date	06.05.2024		Hersteller Manufacturer	Klemmenplan Terminal diagram	BK-Artikel-Nr.: BK-Article-No.:	4301050	=
			Bearbeiter Edited by	ogoyericke		Boll & Kirch Filterbau GmbH	Filtertyp 6.49 ME 1.1 DN200 Filter type 6.49 ME 1.1 DN200	Zeichnungs-Nr.: Drawing-No.:	Z46864	+
REV01	Göricke	12.12.2024	Auftrag Order							Blatt Page
Revision Revision	Bearbeiter Edited by	Datum Date	Vorgang Process				von of		27	

Klemmenplan Terminal diagram

Funktionstext Function text	Kabelname Cable name	Kabeltyp Cable type	-W16	-W15	=+#-WC1-X1 Klemmenbox Terminal box							-W10
					Zielbezeichnung Target designation		Zielbezeichnung Target designation		Blatt Page Pfad Path			
					Bezeichnung Designation	Anschluss Connection	Klemme Terminal	Brücke Jumper		Bezeichnung Designation	Anschluss Connection	
Differenzdrucktransmitter 24VDC (optional) Differential pressure transmitter 24VDC (optional)					-B1	3	20	•		&1/8.5		
Differenzdrucktransmitter 24VDC (optional) Differential pressure transmitter 24VDC (optional)					-B1	1	21	•		-A2	41	&1/8.5
Differenzdrucktransmitter 24VDC (optional) Differential pressure transmitter 24VDC (optional)					-B1	2	22	•		-A2	42	&1/8.5
Strömungsüberwachung Flow monitoring				BN	-B2	1	23	•				&1/8.6
Strömungsüberwachung Flow monitoring				BK	-B2	4	24	•		-A2	36	&1/8.6
Strömungsüberwachung Flow monitoring				BU	-B2	3	25	•				&1/8.7
Strömungsüberwachung Flow monitoring							PE	•				&1/8.7
Druckschalter Öldruck Pressure switch oil pressure				BN	-B3	1	26	•				&1/8.8
Druckschalter Öldruck Pressure switch oil pressure				WH	-B3	2	27	•				&1/8.8
Druckschalter Öldruck Pressure switch oil pressure				BK	-B3	4	28	•		-Q4	14	&1/8.8
Druckschalter Öldruck Pressure switch oil pressure				BU	-B3	3	29	•				&1/8.8
Druckschalter Öldruck Pressure switch oil pressure							PE	•				&1/8.8
Reserve Spare							30	•			&1/9.1	
Reserve Spare							31	•			&1/9.1	

		Datum Date	06.05.2024		Hersteller Manufacturer	Klemmenplan Terminal diagram	BK-Artikel-Nr.: BK-Article-No.:	4301050	=
		Bearbeiter Edited by	ogoeरिके		Boll & Kirch Filterbau GmbH	Filtertyp 6.49 ME 1.1 DN200 Filter type 6.49 ME 1.1 DN200	Zeichnungs-Nr.: Drawing-No.:	Z46864	+
REV01	Göricke	12.12.2024	Auftrag Order						Blatt Page
Revision Revision	Bearbeiter Edited by	Datum Date	Vorgang Process					von of	27

Klemmenplan Terminal diagram

Funktionstext Function text	Kabelname Cable name	=+#-WC1-X1 Klemmenbox Terminal box									
	Kabeltyp Cable type	Zielbezeichnung Target designation					Zielbezeichnung Target designation				
		Bezeichnung Designation	Anschluss Connection	Klemme Terminal	Brücke Jumper	Bezeichnung Designation	Anschluss Connection	Blatt Page Pfad Path			
Reserve Spare				32	·			&1/9.1			
Reserve Spare				33	·			&1/9.2			
Reserve Spare				34	·			&1/9.3			
Reserve Spare				35	·			&1/9.3			

			Datum Date	06.05.2024		Hersteller Manufacturer	Klemmenplan Terminal diagram	BK-Artikel-Nr.: BK-Article-No.:	4301050	=
			Bearbeiter Edited by	ogoricke		Boll & Kirch Filterbau GmbH	Filtertyp 6.49 ME 1.1 DN200 Filter type 6.49 ME 1.1 DN200	Zeichnungs-Nr.: Drawing-No.:	Z46864	+
REV01	Göricke	12.12.2024	Auftrag Order							Blatt Page
Revision Revision	Bearbeiter Edited by	Datum Date	Vorgang Process				von of		27	

Klemmenplan Terminal diagram

Funktionstext Function text	Kabelname Cable name							= + # -X0 Einspeisung Feeder							
								Kabeltyp Cable type	Zielbezeichnung Target designation				Zielbezeichnung Target designation		Blatt Page Pfad Path
									Bezeichnung Designation	Anschluss Connection	Klemme Terminal	Brücke Jumper	Bezeichnung Designation	Anschluss Connection	
Einspeisung vom Netz Power supply input from mains					-W6	-W1	GNYE	-PE		PE	·	-U2	PE1	&1/4.1	
Klemmenbox PE Terminal box PE								-WC1-X1	PE	PE	·	-T1	PE	&1/6.7	

			Datum Date	06.05.2024		Hersteller Manufacturer	Klemmenplan Terminal diagram	BK-Artikel-Nr.: BK-Article-No.:	4301050	=
			Bearbeiter Edited by	ogoricke		Boll & Kirch Filterbau GmbH	Filtertyp 6.49 ME 1.1 DN200 Filter type 6.49 ME 1.1 DN200	Zeichnungs-Nr.: Drawing-No.:	Z46864	+
REV01	Göricke	12.12.2024	Auftrag Order							Blatt Page
Revision Revision	Bearbeiter Edited by	Datum Date	Vorgang Process				von of		27	

Klemmenplan Terminal diagram

Funktionstext Function text	Kabelname Cable name	-W10	= + #-X01						
	Kabeltyp Cable type		Zielbezeichnung Target designation		Zielbezeichnung Target designation				
			Bezeichnung Designation	Anschluss Connection	Klemme Terminal	Brücke Jumper	Bezeichnung Designation	Anschluss Connection	Blatt Page Pfad Path
			-WC1-X1;-A2	12;6		·	-F3		&1/4.7

		Datum Date	06.05.2024		Hersteller Manufacturer	Klemmenplan Terminal diagram	BK-Artikel-Nr.: BK-Article-No.:	4301050	=	
		Bearbeiter Edited by	ogoericke		Boll & Kirch Filterbau GmbH		Filtertyp 6.49 ME 1.1 DN200 Filter type 6.49 ME 1.1 DN200	Zeichnungs-Nr.: Drawing-No.:	Z46864	+
REV01	Göricke	12.12.2024	Auftrag Order							Blatt Page
Revision Revision	Bearbeiter Edited by	Datum Date	Vorgang Process					von of	27	